

GB - "Intelligent" Solar lighting

Congratulations with the purchase of this Intelligent Solar light. You have invested in an economic and safe way to illuminate your terrace or garden.

All lamps of our - Luxform Intelligent LED Solar Series - are equipped with a self-thinking system, which distributes the stored energy evenly over the number of burning hours.

Operation: The battery is charged by the amount of (sun) light that the solar panel captures during a day. The light automatically switches on at dusk; the system of the light detects and calculates the battery capacity and always distributes this energy capacity evenly over 8 hours. This means that when the battery has less charge, the light will light less brightly, as it will adapt to the power reserve in the battery.

The big advantage: The lamp guarantees 8 hours of light every night, 365 days a year!

NL - "Intelligente" zonne-energie

Gefeliciteerd met de aanschaf van deze Intelligente Solarlamp. U heeft geïnvesteerd in een economische en veilige manier om terras of tuin te verlichten.

Alle lampen van onze - Luxform Intelligent LED Solar Serie- zijn voorzien van een zelfdenkend systeem, dat de opgeslagen energie evenredig verdeelt over het aantal branduren.

Werking: De batterij wordt geladen door de hoeveelheid (zon) licht dat het zonnepaneel gedurende deze dag opvangt. Bij schemering gaat de lamp automatisch aan; het systeem in de lamp berekent hoeveel de batterij is opgeladen en verdeelt deze energiecapaciteit altijd gelijkmatig over 8 uur. Dit betekent dat wanneer de batterij minder vol geladen is, de lamp aangepast aan deze stroomreserve ook minder fel zal branden.

Het grote voordeel: De lamp geeft gegarandeerd elke avond 8 uur lang licht, 365 dagen per jaar!

FR - "Énergie" Solaire Intelligent

Félicitations pour l'achat de cette lampe solaire intelligente. Vous avez investi de manière économique et sûre pour éclairer votre patio ou jardin.

Toutes les lampes de notre série - Luxform Intelligent LED Solar Series - sont dotées d'un système qui distribue l'énergie stockée uniformément sur le nombre d'heures de combustion.

Opération: la batterie est chargée par la quantité de lumière (soleil) que le panneau solaire recueille pendant cette journée. La lampe s'allume automatiquement au crépuscule; le système de la lampe calcule combien la batterie est chargée et distribue toujours cette capacité d'énergie uniformément sur 8 heures. Cela signifie que lorsque la batterie n'est pas complètement chargée, la lampe adapte la luminosité au temps de marche (8h).

Le gros avantage: la lampe garantit 8 heures de lumière chaque nuit, 365 jours par an!

DE - "Intelligenter" Solar

Herzlichen Glückwunsch zum Kauf dieser intelligenten Solarleuchte. Sie haben auf eine wirtschaftliche und sichere Weise investiert um Ihre Terrasse oder Ihren Garten zu beleuchten.

Alle Leuchten unserer - Luxform Intelligent LED Solar Serie - sind mit einer neuen Technik ausgestattet, das die gespeicherte Energie gleichmäßig über die Anzahl der Brennstunden verteilt.

Betrieb: Der Akku wird durch das Sonnenlicht aufgeladen, die das Solarpanel der Leuchte an jedem Tag als Energie erfasst. Die Leuchte schaltet sich automatisch bei Dämmerung ein; das System der Leuchte berechnet, wieviel Energie die Batterie geladen hat und verteilt diese Energiekapazität immer gleichmäßig über 8 Stunden. Dies bedeutet, dass wenn die Batterie weniger geladen ist, da passt die Leuchte sich an diese Gangreserve an und stellt die Helligkeit ein.

Der große Vorteil: Die Lampe garantiert 8 Stunden Licht an 365 Tagen im Jahr!

LUXFORM

® LIGHTING

INTELLIGENT LED 20 LUMEN

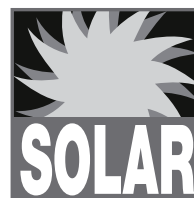

Polaris

LUXFORM
GLOBAL BV

Luxform Global BV Transportstraat 1 8263 BW Kampen The Netherlands

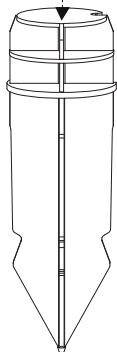
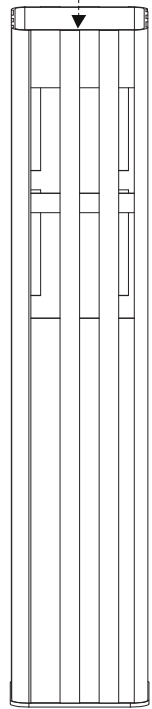
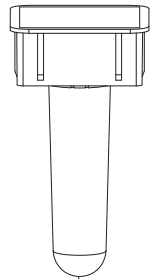

2

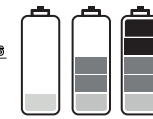
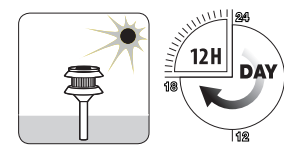
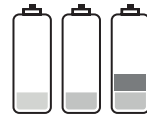
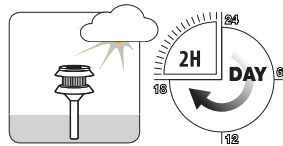

- GB** Note that the light brightness shall dim automatically, depending on the day's charge of the battery
This guarantees 8 hours of light output.
- NL** Merk op dat de lichtsterkte automatisch aangepast wordt, afhankelijk van de daglading van de batterij.
Hierdoor 8 uur brandtijd gegarandeerd.
- F** Notez que la luminosité doit baisse automatiquement en fonction de la charge journalière de la batterie.
Cela garantit 8 heures de rendement lumineux.
- D** Bitte beachten Sie, dass die Helligkeit der Leuchte abhängig ist von dem Tagesladezustand des Akkus.
So wird 8 Stunden Lichtleistung garantiert.

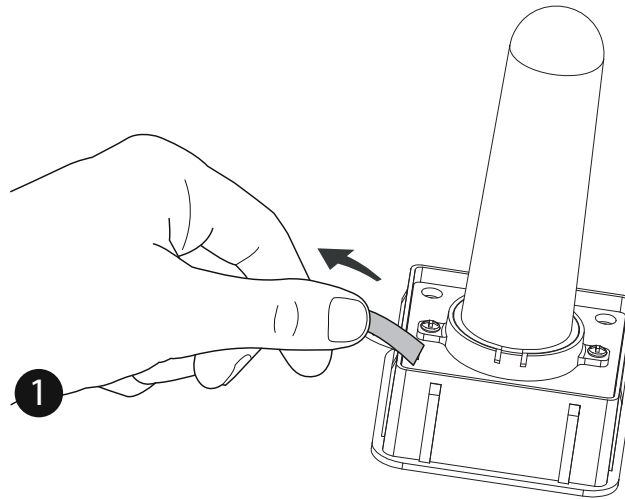

1

